



Laboratory Equipment Manufacturer  
www.mrclab.com



# INSTRUCTION MANUAL FOR

# **BWLC-0.01g series**

## Precision Balances



**PLEASE READ THIS MANUAL CAREFULLY BEFORE OPERATION**

3, Hagavish st. Israel 58817 Tel: 972 3 5595252, Fax: 972 3 5594529 [mrc@mrclab.com](mailto:mrc@mrclab.com)

MRC.7.20





# TABLE OF CONTENTS

<b>1. INTENDED USE</b>	<b>6</b>
<b>2. PRECAUTIONS</b>	<b>7</b>
2.1. Maintenance	7
2.2. Accumulator / battery pack	7
2.2.1. Power supply of scales BWLC C1...C2	8
2.2.2. Replacement of worn batteries	8
2.3. Operation in a strong electrostatic field	9
<b>3. WARRANTY CONDITIONS</b>	<b>9</b>
<b>4. MAIN DIMENSIONS</b>	<b>10</b>
<b>5. UNPACKING AND ASSEMBLY</b>	<b>12</b>
<b>6. GETTING STARTED</b>	<b>13</b>
<b>7. BALANCE LEVELLING</b>	<b>14</b>
<b>8. KEYPAD</b>	<b>14</b>
<b>9. KEYS' FUNCTIONS</b>	<b>15</b>
<b>10. INSCRIPTIONS ON THE DISPLAY</b>	<b>16</b>
<b>11. USER MENU</b>	<b>17</b>
11.1. Submenus	17
11.2. Browsing user menu	18
11.2.1. Keypad	18
11.2.2. Return to the weighing mode	18
<b>12. WEIGHING</b>	<b>19</b>
12.1. Tarring	20
12.2. Inscribing tare value	20
12.3. Zeroing	21
12.4. Weighings in two ranges	21
12.5. Selection of basic weight unit	23
12.6. Temporarily selected unit	24
<b>13. MAIN PARAMETERS</b>	<b>25</b>
13.1. Setting a filtering level	25
13.2. Median filter	26
13.3. Autozero function	27
13.4. Tare function	28
<b>14. RS 232 PARAMETERS</b>	<b>29</b>
14.1. Printout type	29
14.2. Minimal mass threshold	30
14.3. Baud rate	31
14.4. Serial transmission parameters	32
<b>15. OTHER PARAMETERS</b>	<b>33</b>
15.1. Backlight function	33
15.1.1. Backlight for supplying from mains	33
15.1.2. Backlight for supplying from batteries	34
15.2. "Beep" signal – after pressing a key	35
15.3. Automatic switch-off	35
15.4. Battery voltage level check	36
15.4.1. Checking the batteries	36
15.4.2. Battery discharge pictogram	37
15.4.3. Accumulator charging option	37
15.4.4. Formatting rechargeable battery packs	38
<b>16. OPERATION MODES</b>	<b>39</b>
16.1. Setting accessibility of operation modes	39
16.2. Selecting quantity of operation modes	40
16.3. Counting pieces of the same mass	41

16.4. +/- control referring to the inscribed standard mass.....	43
16.5. Control of % deviation referring to the inscribed standard mass.....	45
16.5.1. Standard mass determined by its weighing.....	45
16.5.2. Mass of standard inscribed to scale memory.....	47
16.6. Automatic tare.....	48
16.7. Measurement of maximal force on the pan – latch.....	49
16.8. Totalizing.....	49
16.8.1. Enabling the work mode.....	50
16.8.2. Totalizing procedure.....	50
16.8.3. Memory of the last value of sum of weighed goods.....	51
16.8.4. Return to weighing.....	52
16.9. Weighing animals.....	53
16.10. Tare memory.....	54
16.10.1. Entering the tare value to the scale memory.....	54
16.10.2. Selecting a tare value from the memory.....	56
<b>17. SCALE CALIBRATION.....</b>	<b>57</b>
17.1. Internal calibration.....	57
17.1.1. Manual internal calibration.....	58
17.1.2. Automatic internal calibration.....	59
17.1.3. A report from calibration.....	62
17.2. External calibration.....	63
17.3. Start mass adjustment.....	64
<b>18. COOPERATION WITH PRINTER.....</b>	<b>66</b>
<b>19. COOPERATION WITH COMPUTER.....</b>	<b>67</b>
<b>20. COMMUNICATION PROTOCOL.....</b>	<b>68</b>
20.1. General information.....	68
20.2. A set of commands for RS interfaces.....	68
20.3. Respond message format.....	69
20.4. Command's description.....	69
20.4.1. Zeroing.....	69
20.4.2. Tarring.....	69
20.4.3. Get tare value.....	70
20.4.4. Send the stable result in basic unit.....	70
20.4.5. Send the result immediately in basic unit.....	71
20.4.6. Send the stable result in current unit.....	71
20.4.7. Send the result immediately in current unit.....	72
20.4.8. Switch on continuous transmission in basic unit.....	73
20.4.9. Switch off continuous transmission in basic unit.....	73
20.4.10. Switch on continuous transmission in current unit.....	73
20.4.11. Switch off continuous transmission in current unit.....	74
20.4.12. Send all implemented commands.....	74
20.5. Manual printouts / automatic printouts.....	74
20.6. Continuous transmission.....	75
20.7. Configuring printouts.....	76
<b>21. ERROR COMMANDS.....</b>	<b>76</b>
<b>22. TROUBLE SHOOTING.....</b>	<b>77</b>
<b>23. TECHNICAL PARAMETERS.....</b>	<b>78</b>
23.1. Precisions scales of BWLC series.....	78
23.2. Verified precise scales of BWLC series.....	79
23.3. Precise scales of BWLC...C2 series.....	80
23.4. Verified precise scales of BWLC...C2 series.....	80
<b>24. ADDITIONAL EQUIPMENT.....</b>	<b>81</b>

## 1. INTENDED USE

Scales are designed for fast and precise measurements of weighed loads masses and direct commercial settlements. Tarring in full weighing range enables to determine net mass of weighed loads. Additional display is additional equipment of scale.

### Functions:

- backlight of display
- level of filtration
- autozero function
- setting baud rate of transmission
- continuous data transmission for RS 232
- automatic operation for RS 232
- designed printouts
- designation minimum mass for function operating
- counting pieces
- +/- mass control
- percentage deviation from standard mass
- latch of maximum scale indication
- automatic tare
- memory of tare
- inscribing tare value
- Memory of 9 tare values
- automatic scale switch-off
- user calibration
- internal calibration
- Totalizing
- Weighing animals

User functions may have attribute of accessibility. For this reason it is possible to adjust scale to individual needs to provide access to only these functions which are currently needed. Attribute determination accessible / inaccessible is possible in user menu and described in further part of manual.

## 2. PRECAUTIONS

### 2.1. Maintenance

- A. Please, read carefully this user manual before and use the device according to its intended use.
- B. Devices that are to be withdrawn from use age should be sent back to the producer or in case of own utilization do it according to the law.

### 2.2. Accumulator / battery pack

The device connected to mains intelligently monitors the battery state and charges it if possible. After sudden lack of power supply from the mains the device automatically switches to accumulator without breaking operation.

- **BWLC-C1...C2** and **BWLC-B1** scales are devices designed to be supplied from **NiMH** batteries (nickel-metal-hydrogen) with rated voltage of **1.2V**, size **R6** and capacities from **1800** to **2800mAh** charged while connected to mains without stopping operation.
- **BWLC-A2** and **BWLC-C2** scales are devices designed to be supplied from **SLA** accumulators (*Sealed lead acid type*) **6V** o and capacity **3** to **4Ah** charged while connected to mains without stopping operation.



**In case of an elongated storage period in low temperatures, it is not allowed the full discharge of the accompanied batteries.**



**The equipment including accumulators does not belong to your regular household waste. The European legislation requires that electric and electronic equipment be collected and disposed separately from other communal waste with the aim of being recycled.**

**Notice:**

*Some symbols on accumulators identify harmful elements/compounds:*

*Pb = lead,*

*Cd = cadmium,*

*Hg = mercury.*

### 2.2.1. Power supply of scales BWLC-C1...C2

**BWLC-C1...C2** scales are intended to be supplied from a power adapter or from NiMH rechargeable battery pack (standard equipment). New rechargeable batteries should be formatted according to the description in the chapter 15.4.4. of this manual.

Alternatively, you can use to power the device R6 size standard non-rechargeable batteries. If you want to use normal batteries instead of rechargeable ones, proceed as follows:

- Before installing non-rechargeable batteries turn on the device and set **<5.5.Chr6>** to **<no>**, to switch off charging.
- Then install the batteries.



**Installing batteries without changing <5.5.Chr6> to <no> may cause damage of batteries and the indicator.**

### 2.2.2. Replacement of worn batteries

Users of scales **BWLC-C1...C2** can exchange worn out accumulators to new ones.

#### Procedure:

- Open the lid of the chamber for batteries placed in the bottom of the indicator casing:
- Remove discharged and then insert new batteries into the chamber, according to given polarity (+/-):

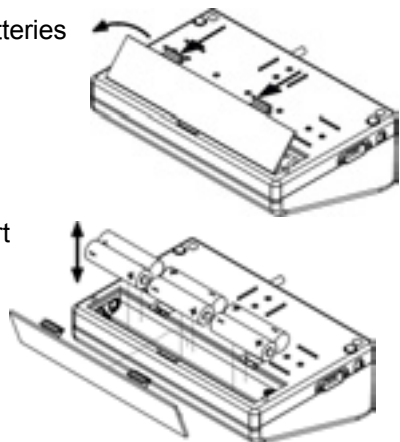



- Close the lid of the chamber for batteries:

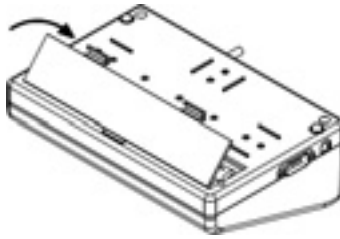

**In BWLC-A2, BWLC-C2 and BWLC-B1 scales the worn out accumulator can be exchanged to a new one by the authorized service of the manufacturer.**

### **2.3. Operation in a strong electrostatic field**

If the device is about to operate in a strong electrostatic field (e.g. printing houses etc.) it should be connected to the earthing.

Connect it to the clamp terminal signed .

## **3. WARRANTY CONDITIONS**

- A. MRC is obliged to repair or change those elements that appears to be faulty because of production and construction reason,
- B. Defining defects of unclear origin and outlining methods of elimination can be settled only in participation of a user and the manufacturer representatives,
- C. MRC does not take any responsibility connected with destructions or losses derives from non-authorized or inappropriate (not adequate to manuals) production or service procedures,
- D. Warranty does not cover:
  - Mechanical failures caused by inappropriate maintenance of the device or failures of thermal or chemical origin or caused by atmospheric discharge, over voltage in mains or other random event,
  - Inappropriate cleaning.

- E. Loss of warranty appears after:
  - Access by an unauthorized service,
  - Intrusion into mechanical or electronic construction of, unauthorized people,
  - Removing or destroying protection stickers.
- F. Warranty conditions outline the warranty period for rechargeable batteries attached to the device for 12 months.
- G. The detailed warranty conditions one can find in warranty certificate.
- H. Contact with the central authorized service:  
+972-3-5595252.

#### 4. MAIN DIMENSIONS

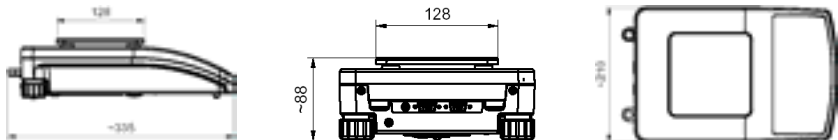

*Scales BWLC-A1-C2*

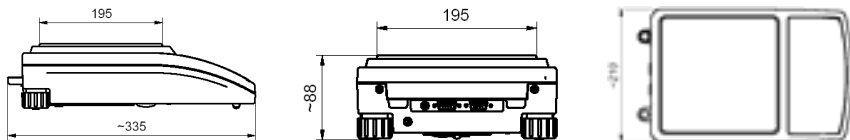

*Scales BWLC-A2, WLC-A2-C2*

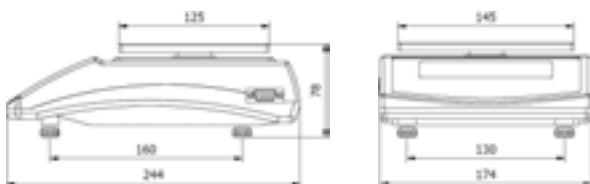

*Scales BWLC-B1*

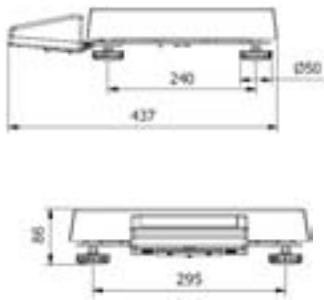

*Scales BWLC-C1-R*

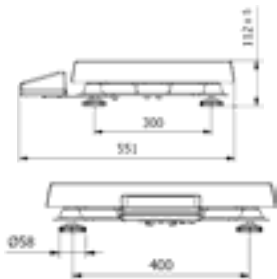

*Scales BWLC-C2-R*

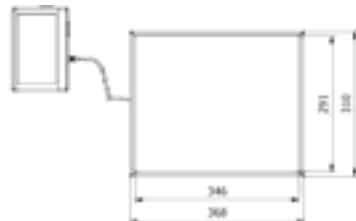
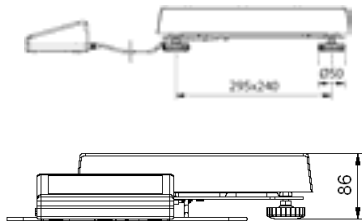

*Scales BWLC-C1-K*

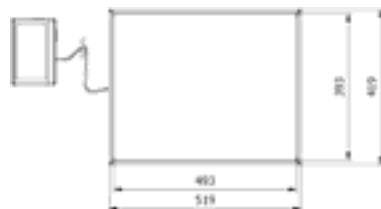
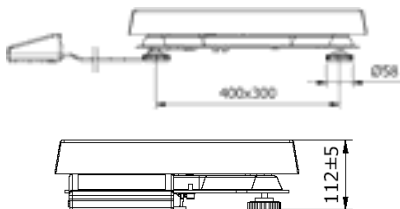

*Scales BWLC-C2-K*

## 5. UNPACKING AND ASSEMBLY

- Unpack and put the scale on a flat even stable surface far away from sources of heat,
- Remove the transport protection:

– Scales BWLC...C2:

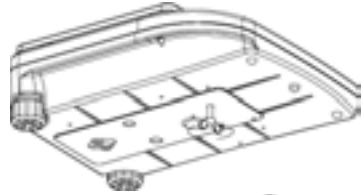

– Scales BWLC-B1:

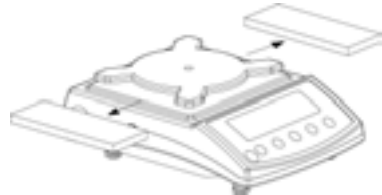

– Scales BWLC-C-K, BWLC-C-R:



- Install the weight pan according to the drawings below:

– Scales BWLC-A1-C2:

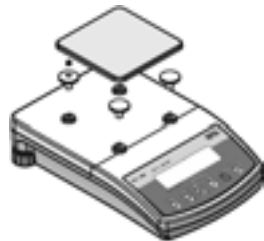

– scales BWLC-A2, BWLC-A2-C2:



- scales BWLC-B1:



- scales BWLC-C-K:



- scales BWLC-C-R:



## 6. GETTING STARTED

- After unpacking and mounting the scale level it out. Use levelling legs and the level condition indicator installed in the basis of the scale.



- Turn the device on using the  key – keep pressing the key for about 0.5 sec,
- Wait for the test completion,
- Then you will see **zero indication** and pictograms:

 - zero indication

 - stable result

**kg** - weight unit

- If the indication is not zero press  key.

**Caution:**

*In case of verified scales in II OIML class with divisions  $e=10d$  (where:  $d$  – reading division,  $e$  – verified division) the last digit will be marked as shown below:*

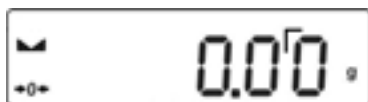

## 7. BALANCE LEVELLING

- Operation temperature range for this device is outlined as  $+15^{\circ}\text{C} \div +30^{\circ}\text{C}$ ;
- After powering up this device requires 30 minute worming up;
- During the worm-up time the indication can change;
- User calibration should be performed after the warm-up time.
- Temperature and humidity changes during operation can increase measurement errors, which can be minimized by performing the user calibration process.

## 8. KEYPAD

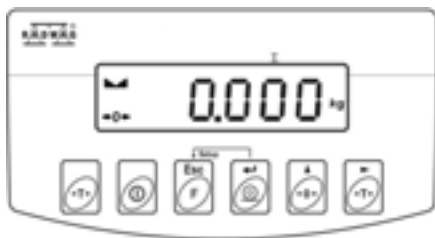

*Keypad of BWLC-A2 series*

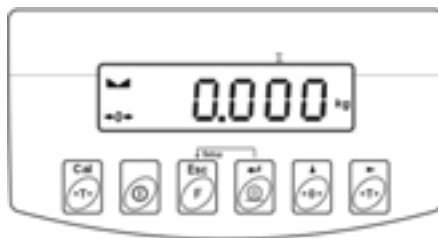

*Keypad of BWLC...C2 series*



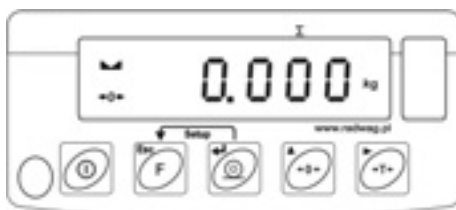

Keypad of BWLC-C1...C2 series









Keypad of BWLC-B1 series



**Notice:**

Scales of BWLC-A2 series are equipped with an additional key  for tarring and has no additional functions but the keypad of the BWLC...C2 scale include an additional key  for direct starting the process of internal calibration. Because the functionality and operation of the rest of the keys is the same, the further part of this manual describes the keypad of BWLC-C1...C2 series.



**9. KEYS' FUNCTIONS**

-  Switching on/off
-  Function key (operation mode selection)
-  Sending a weighing result to RS232
-  Zeroing
-  Tarring
-  Manual internal calibration (BWLC...C2 scales)

**Notice:**

After pressing  +  keys' functions changes. The way of operation in this mode is described in details further in this manual.

## 10. INSCRIPTIONS ON THE DISPLAY

No	Text string	Description
1	<b>FIL</b>	Filter level
2	<b>bAud</b>	Transmission baud rate
3	<b>PCS</b>	Piece counting
4	<b>HiLo</b>	+/- control according to a standard mass
5	<b>rEPL</b>	Automatic printout
6	<b>StAb</b>	The condition of printing data
7	<b>Auto</b>	Autozero correction
8	<b>t1</b>	Power save – time to switch off while no operation
9	<b>toP</b>	Latch of the max measurement
10	<b>Add</b>	Totalizing
11	<b>AnLS</b>	Weighing animals
12	<b>tArE</b>	Memory of 9 tare values
13	<b>-0-</b>	Indication in autozero zone (indication = exact zero)
14		Stable result (ready to read)
15	<b>PCS</b>	Operation mode - counting pieces
16	<b>kg (g)</b>	Operation mode - weighing
17		Rechargeable battery pack or battery discharged (BAT-LO)
18	<b>Net</b>	Tare function has been used
19	<b>Min</b>	+/- control with reference to the standard mass: setting the lower threshold or mass below the first threshold
20	<b>OK</b>	+/- control with reference to the standard mass: load mass between the thresholds
21	<b>Max</b>	+/- control with reference to the standard mass: setting the upper threshold or mass over the second threshold
22	<b>CALib</b>	The stability test for the internal calibration procedure
23	<b>CAL-H</b>	Manual internal calibration
24	<b>CAL-A</b>	Automatic internal calibration after powering up
25	<b>CAL-t</b>	Internal calibration triggered of by temperature
26	<b>CAL-C</b>	Internal calibration triggered of by timer
27	<b>Abort</b>	Terminating of internal calibration



# 11. USER MENU

## 11.1. Submenus

User's menu is divided into **6** basic submenus. Each group has its own characteristic name preceded by the letter **P** and a number.

### **P1 rEAd**

P 1.1	Fil		3
P 1.2	Auto		YES
P 1.3	tArA		no
P 1.4	Fnnd		YES

### **P2 Prnt**

P2.1	Pr_n		StAb
P2.2	S_Lo		
P2.3	bAud		9600
P2.4	S_rS		8d1SnP

### **P3 Unit**

P3.1	StUn		kg
------	------	--	----

### **P4 Func**

P4.1	FFun		ALL
P4.2	Funi		no
P4.3	PcS		no
P4.4	HiLo		no
P4.5	PrcA		no
P4.6	Prcb		no
P4.7	AtAr		no
P4.8	toP		no
P4.9	Add		no
P4.A	AnLS		no
P4.b	tArE		no

### **P5 othr**

P5.1	bL		Auto
P5.2	bLbt		70
P5.3	bEEP		YES
P5.4	t1		Auto
P5.5	CHr6		YES

### **P6 CAL**

P6.1	St_u		* FUNCTION *
P6.2	uCAL		* FUNCTION *
P6.3	CA-C		0
P6.4	CA-r		YES

## 11.2. Browsing user menu

Use scale's keys to move inside the menu.

### 11.2.1. Keypad

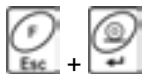

Entering main menu



Inscribing tare value  
Increasing a digit value by „1”  
moving down in the menu

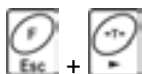

Battery / accumulator state monitoring

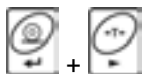

Toggling between gross / net values



Selecting the parameter or changing the value  
of a selected parameter



Entering the selected submenu  
or activating a parameter for changes



Confirmation (enter)



Leaving without changes or reaching a higher level  
of the menu

### 11.2.2. Return to the weighing mode



The changes that have been introduced should be saved  
in order to keep them in the memory for good.

While leaving parameters press  key until the text **<SAuE?**

**>** appears on the display. Then press: 

– to save changes or  – to leave without changes.

## 12. WEIGHING

Put a load you want to weigh on the weighing pan. When the  appears it means that the result is stable and ready to read. In order to assure long-term operation and appropriate measurements of weighted loads following precautions should be taken into consideration:

- Loads should be placed on the pan delicately and carefully in order to avoid mechanical shocks:

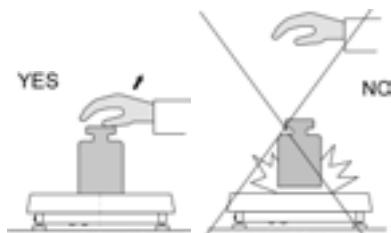

- Loads should be placed centrally on the pan (errors caused by eccentric weighing are outlined by standard PN-EN 45501 ch. 3.5 and 3.6.2):

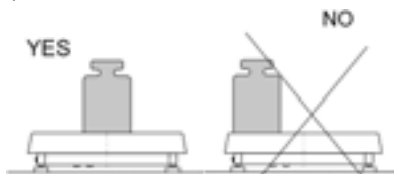

- Do not load the pan with concentrated force:

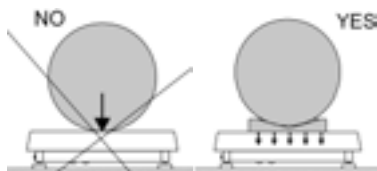

- Avoid side loads, particularly side shocks should be avoided

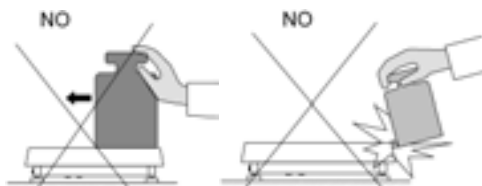

## 12.1. Tarring

In order to determine the net mass put the packaging on the pan.

After stabilising press  (**Net** pictogram will be displayed in the left upper corner and zero will be indicated).



After placing a load on the weight pan net mass will be shown.

Tarring is possible within the whole range of the scale. After unloading the pan the display shows the tarred value with minus sign.

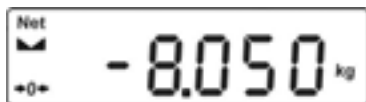



### **Notice:**



*Tarring cannot be performed when a negative or zero value is being displayed. In such case **Err3** appears on the display and short audible signal will be emitted.*

## 12.2. Inscribing tare value

You can also inscribe a tare value. While in weighings mode press:

- Press simultaneously  and ,
- You will see :





- Using  and  set the tare value,
  - Press ,
  - Program returns to weighings mode. The inscribed tare value can be seen on the display with „-“ sign,
  - Tare can be inscribed anytime in weighings mode.

**Notice:**

1. You cannot inscribe a new tare value when the tare value in memory is greater than zero. In the case of trying this the **<Err3>** message will be displayed and short audible signal will be emitted.
2. Users can also enter up to 9 tare values to the scale memory (see 16.10 of his manual).

**12.3. Zeroing**

To **ZERO** the scale press: .

The scale will display zero and following pictograms: **-0-** and . Zeroing is only possible within the scope of **±2%** of full scale. While zeroing outside the scope of **±2%** you will see **<Err2>**. Zeroing is possible only in stable state.

**Notice:**

*Zeroing is possible only within the **±2%** interval of the maximal range. If zeroing is performed beyond this range the **<Err2>** message and short audible signal will be emitted.*

**12.4. Weighings in two ranges**

Switching between the **I range** and the **II range** happens automatically (exceeding Max of the **I range**). Weighings in the second range is signalled by a pictogram in the top left corner of the display.

Then weighings is done with the accuracy of the **II range** to the moment of returning to zero (autozero range **-0-**) where the scale switches back to the **I range**.

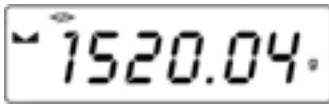

## 12.5. Selection of basic weight unit

This function is used to set weight unit the scale will start with.

### Procedure:

- Enter the submenu **<P3.Unit>** and then:



- press , until the expected unit appears on the display:



### Options:

- When the basic unit is [kg], users can toggle between: [kg, lb, N], *for verified scales [lb] is not accessible,*
- If the basic unit is [g], users can toggle between: [g, ct, lb], *for verified scales [lb] is not accessible,*

- After you select the unit press , the scale returns to:

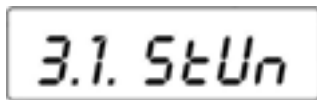

- Return to weighing according to chapter - 11.2.2.

**Notice:**

*After turning on the scale always sets the basic unit.*

**12.6. Temporarily selected unit**

This function is used to set weight unit the scale will use temporarily until the next power off or next selection.

**Procedure:**

- Press  and then:

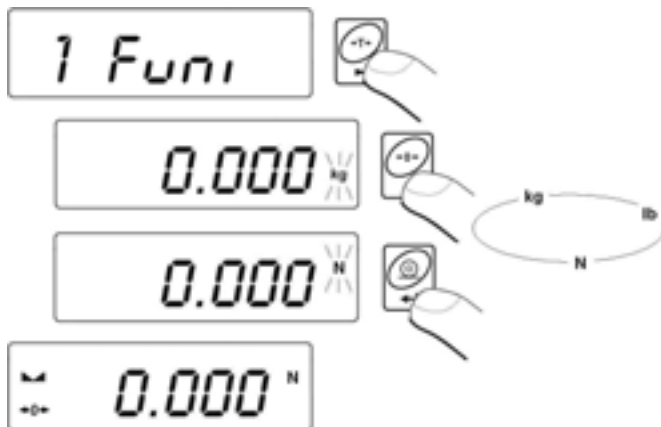

- After you select the unit you want come back to weighing procedure.



## Options:

- A. When [kg] is a basic unit, users can select following units:  
[kg, lb, N], *[lb] is not accessible for verified scales.*
- B. When [g] is a basic unit, users can select following units:  
[g, ct, lb], *[lb] is not accessible for verified scales.*

## 13. MAIN PARAMETERS

Users can adjust the scale to external ambient conditions (filtering level) or particular needs (autozero operation, tare memory). This parameters are placed in <P1.rEAd> submenu.

### 13.1. Setting a filtering level

#### Procedure:

- Enter the submenu <P1.rEAd> and then:

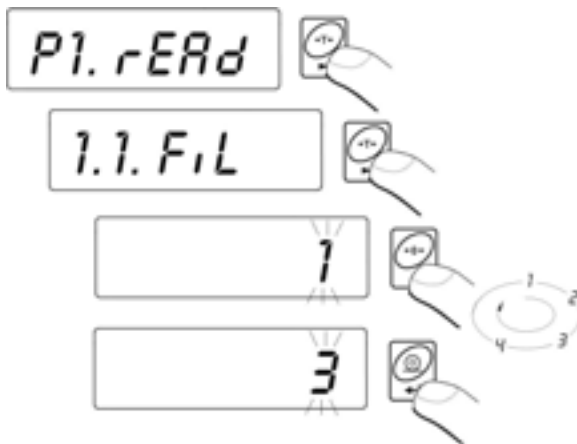

1 - 4 - level of filtering

- By pressing  select the filtering level you need

**Notice:**

*Filtering level influences the time of stabilization. The higher the filtering level is the longer stabilization time is needed.*

**Return to weighing:**

See - 11.2.2.

**13.2. Median filter**

This filter eliminates short changes (impulses) of measure signal (e.g. shocks).

**Procedure:**

- Enter the submenu **<P1.rEAd>** and then:





**Fnnd**    **no**    - filter disabled  
**Fnnd**    **YES**    - filter enabled

**Return to weighing:**

See - 11.2.2.

### 13.3. Autozero function

The autozero function has been implemented in order to assure precise indications. This function controls and corrects „0” indication. While the function is active it compares the results continuously with constant frequency. If two sequential results differ less than the declared value of autozero range, so the scale will be automatically zeroed and the pictograms  and  will be displayed.

When AUTOZERO is disabled zero is not corrected automatically. However, in particular cases, this function can disrupt the measurement process e.g. slow pouring of liquid or powder on the weighing pan. In this case, it is advisable to disable the autozero function.

#### Procedure:

- Enter the submenu **<P1.rEAd>** and then:



**Fnnd**    **no**    - filter disabled  
**Fnnd**    **YES**    - filter enabled

#### Return to weighing:

See - 11.2.2.

### 13.4. Tare function

This parameters enables users to configure a tare function.

#### Procedure:

- Enter the submenu **<P1.rEAd>** and then:



- tArA AtAr** - **automatic tare function on** and is stored in balance memory after unplugging it from mains (Description of function operating point 16.6 automatic tare)
- tArA no** - **automatic tare function off** (user can turn on operating of automatic tare F6 AtAr – till unplugging the balance from mains)
- tArA tArF** - **tare memory function** – stores last value of tare in balance memory. It is automatically displayed after starting the balance. Value of tare is displayed with minus sign, and there is **Net** symbol indicated on the display. (user can turn on operating of automatic tare **F6 AtAr** – till unplugging the balance from mains)

#### Return to weighing:

See - 11.2.2.

## 14. RS 232 PARAMETERS

External devices connected to RS 232C have to be supplied from the same mains and common electric shock protection. It prevents from appearing a potential difference between zero leads of the two devices. This notice does not apply to the devices that do not use zero leads.

### Transmission parameters:

- Baud rate - 2400 – 38400 bit / s
- Data bits - 7,8
- Stop bits - 1,2
- Parity control - no, even, odd

### There are four ways of sending data via RS232 interface:

- **Manually** – after pressing ,
- **Automatically** – after stabilizing the indication over **-LO-** threshold
- **Continuously** – after it is activated in parameter or by a command sent via RS232
- **On external request** - see - „List of scale - computer commands”.

### The indication can be sent as:

- **stable** – the indication is sent after the scale stabilizes.
- **any** – the indication is sent immediately after pressing the  key, this state is assign with <?> in the printout.

### 14.1. Printout type

This parameter is to select the type of printout.

#### Procedure:

- Enter the submenu **<P2.Prnt>** and then:

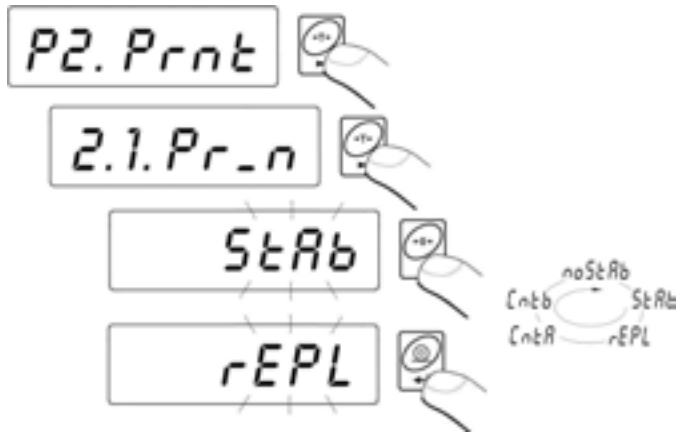

- |             |               |   |
|-------------|---------------|---|
| <b>Pr_n</b> | <b>noStAb</b> | - immediate printout<br>(not accessible in verified scales) |
| <b>Pr_n</b> | <b>StAb</b>   | - sending stable results                                    |
| <b>Pr_n</b> | <b>rEPL</b>   | - automatic operation                                       |
| <b>Pr_n</b> | <b>CntA</b>   | - continuous transmission in basic unit                     |
| <b>Pr_n</b> | <b>Cntb</b>   | - continuous transmission in present unit                   |

**Return to weighing:**  
see 11.2.2.

## 14.2. Minimal mass threshold

This function is necessary while working with **automatic tare** or **automatic operation** or **weighing animals**.

**Automatic tarring** will not be applied until the indication (gross) is lower than the value inscribed in **S\_Lo** parameter.

**In automatic operation** measurements (net) are sent via RS232 when the indication is equal or greater than the value inscribed in **S\_Lo** parameter.

**Weighings animals** is performed when the indication is equal or greater than the value inscribed in **S\_Lo** parameter.

### Procedure:

- Enter the submenu **<P2.Prnt>** and then:

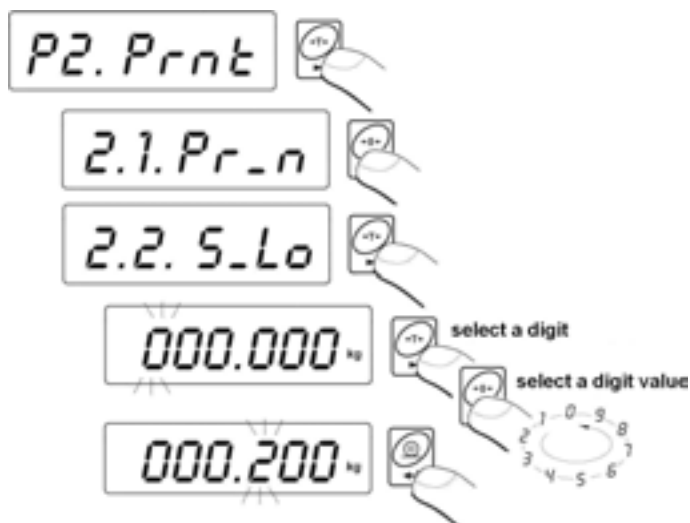

**Return to weighing:**  
see 11.2.2.

### 14.3. Baud rate

**Procedure:**

- Enter the submenu **<P2.Prnt>** and then:

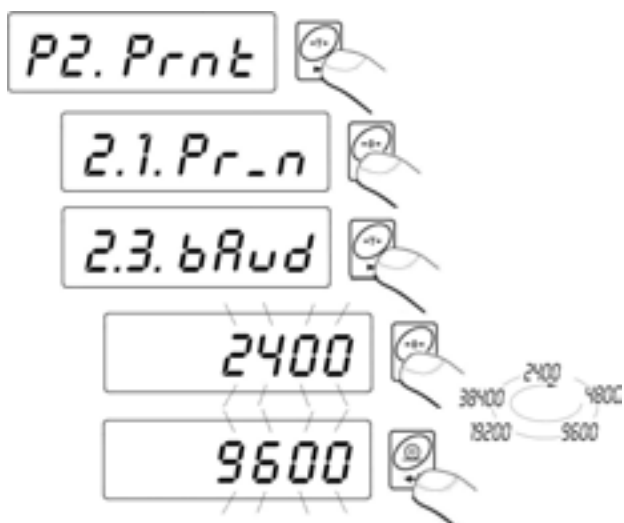

**Return to weighing:**  
see 11.2.2.

#### 14.4. Serial transmission parameters

**Procedure:**

- Enter the submenu **<P2.Prnt>** and then:

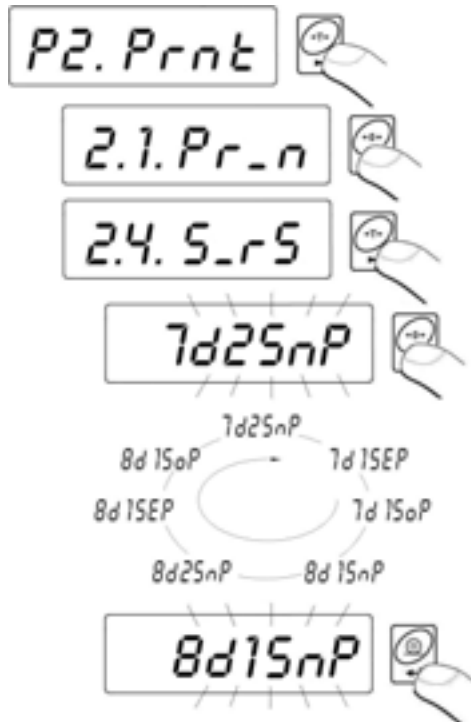

- 7d25nP** - 7 data bits; 2 stop bits, no parity control
- 7d1SEP** - 7 data bits; 1 stop bit, EVEN parity control
- 7d1SoP** - 7 data bits; 1 stop bit, ODD parity control
- 8d15nP** - 8 data bits; 1 stop bit, no parity control
- 8d25nP** - 8 data bits; 2 stop bits, no parity control
- 8d1SEP** - 8 data bits; 1 stop bit, EVEN parity control
- 8d1SoP** - 8 data bits; 1 stop bit, ODD parity control

**Return to weighing:**  
See 11.2.2.



## 15. OTHER PARAMETERS

The user can set parameters which influence the scale operation. They are gathered in the submenu **<P5.othr>** e.g. backlight and beep signal. Enter this submenu **<P5.othr>** according to chapter 11.2.

### 15.1. Backlight function

Program recognises the way the scale is supplied (mains, battery) and automatically selects the way of operating on the backlight:

- bl** – for mains,
- blbt** – for batteries or rechargeable battery pack.

#### 15.1.1. Backlight for supplying from mains

##### Procedure:

- Enter the submenu **<P5.othr>** and then:



- bl no** - backlight switched off
- bl YES** - backlight switched on
- bl Auto** - backlight switched off automatically if indication becomes stable for about 10s

**Return to weighing:**  
See 11.2.2.

**Notice:**

*When bl=Auto, and the indication has not changed for 10s, the backlight is automatically switched off. The backlight is switched on again automatically after the result changes.*

**15.1.2. Backlight for supplying from batteries**

The user can change the intensity of backlight from 0% to 100%. The lower the intensity is the longer the scale operates without recharging or exchanging batteries. When the intensity is set this function works as AUTO (described above).

**Procedure:**

- Enter the submenu **<P5.othr>** and then:

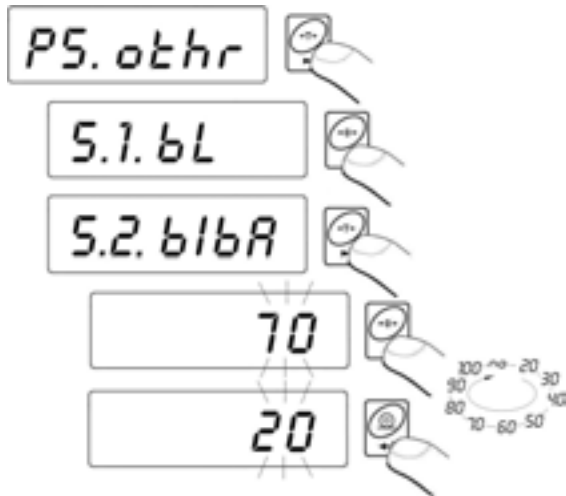

**Return to weighing:**  
See 11.2.2.

**Notice:**

*The more intense the backlight is the shorter the scale operates on batteries.*

## 15.2. “Beep” signal – after pressing a key

### Procedure:

- Enter the submenu <P5.othr> and then:



**bEEP**    **no**    - switched off  
**bEEP**    **YES**    - switched on

### Return to weighing:

See 11.2.2.

## 15.3. Automatic switch-off

This function is essential to save the battery power. The scale is switched off automatically when (function **t1 = YES**) no weighing appears in 5 minutes. (no changes on the display). In case when this function disrupts the operation (e.g. long time weighing procedures) or while working with connection to mains, switch off this function.

### Operation according to the power supply:

Setting	Operation	
	Mains	Batteries / accumulator
t1 = 0	disabled	disabled
t1 = YES	enabled	enabled
t1 = Auto *	disabled	enabled

\* automatic enabling/disabling according to the source of power.

**Procedure:**

- Enter the submenu **<P5.othr>** and then:



**Return to weighing:**

See 11.2.2.

**15.4. Battery voltage level check**

While supplying from batteries too low level of voltage is measured by software the pictogram  is displayed. It means that charging or exchanging batteries is required.

**15.4.1. Checking the batteries**

This function is to check the level of battery supply. It works only if:

- Weighing mode is set,
- Battery supply is set in parameters.

**Procedure:**





After displaying the level of batteries (in per cents) the program returns to weighing.

**15.4.2. Battery discharge pictogram**



The symbol (bat low) switches on when the voltage level drops to 18% of the accepted level of voltage. It means that charging or exchanging batteries is required.

**Low level of batteries:**

-  pictogram on the display,
- After some time the device will automatically switch off to protect the batteries from destructible discharging,
- Charging is signalled by  (blinking period about 2 seconds) on the display.

**15.4.3. Accumulator charging option**

This function allows to switch on charging algorithm for **NiMH** batteries (for scales of BWLC C1...C2, BWLC-B1 series) or a gel cell **SLA** accumulator (for scales of BWLC-A2, BWLC...C2 series):

- a) Parameter **<CHR6>** set to **<no>**:
  - Pictogram  does not appear, charging disabled,
  - During software initializing, after turning on **<bAtt>**.
- b) Parameter **<CHR6>** set to **<YES>**:
  - Pictogram  blinks slowly (period about 2 seconds), charging is enabled,

- Message **<nimh>** appears on the display (for scales of BWLC C1...C2, BWLC-B1 series) or **<SLA>** (for scales of BWLC-A2, BWLC...C2 series),
  - In case of damaging accumulators or lack of it the pictogram  blinks quickly (period about 0.5 sec).

**Notice:**

*BWLC-C1...C2 and BWLC-B1 scales are equipped with **NiMH** batteries packs, **R6 (AA)** size and Power adapters for supplying from mines.*

**Procedure:**

- Enter the submenu **<P5.othr>** and then:



**CHR6 YES** - enabled  
**CHR6 no** - disabled

**Return to weighing:**

See 11.2.2.

**15.4.4. Formatting rechargeable battery packs**

BWLC-C1...C2 and BWLC-B1 scales are equipped with **NiMH** batteries packs, **R6 (AA)** size and Power adapters for supplying from mines. They need formatting after first powering up. It is crucial for batteries lifetime to undertake this process. Formatting consist in charging and total discharging (without meantime charging).

**Procedure:**

1. Supply the indicator from mains,
2. Charge batteries for 12 hours (time of charging 2200mAh batteries),
3. After 12 hours unplug from mains,
4. Use the device up to the moment of self powering down,
5. Repeat the process of charging starting from point 1.

**Notice:**

*They reach their optima capacity after three cycles of full charging and discharging.*

## 16. OPERATION MODES

### 16.1. Setting accessibility of operation modes

In this parameter group users can disable/enable accessibility of functions after pressing  key.

**Procedure:**

- Enter the submenu **<P4.Func>** and then:



- no** – mode is disabled
- YES** – mode is enabled

**Return to weighing:**  
See 11.2.2.

## 16.2. Selecting quantity of operation modes

This function enables user to set if ,after pressing  key, all operating modes will be accessible (**ALL**) or only one from the list chosen and used by operator.

### Procedure:

- Enter the submenu **<P4.Func>** and then:



After choosing setting press  key. The program will return to displaying name of submenu **<P4.1.FFun>**.

**Return to weighing:**  
See 11.2.2.



### 16.3. Counting pieces of the same mass

Standard solution is equipped with option of counting small pieces of the same mass. It is possible to execute a tare function in this operating mode in order to tare a container value.

#### Notice:

1. Counting pieces does not work together with other scale functions,
2. The counting pieces function is not saved as a default start function so it is not remembered after restarting.

#### Procedure:

- Enter to **<PcS>** function:





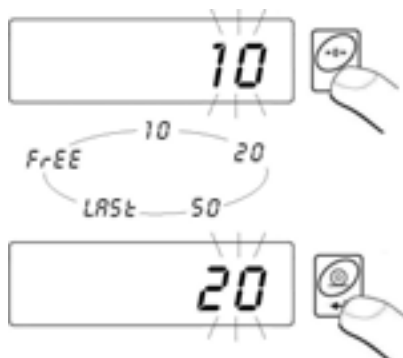

- You will see a blinking value of sample quantity.
- Press  key to start setting quantity of sample, you have a few options to chose from:



- If option **<LAST>** is chosen in the scale program displays estimated unit mass of the last piece (about 3 seconds) and then goes to **Counting pieces** automatically setting the previously displayed value as valid for the procedure.

- If the **<FrEE>** option is selected you will see:



- Using  and  enter the required sample quantity, where:  - selection of digit position,  - setting the digit,

- Confirm the value by pressing ,
- You will see **<LoAd>** on the display and then:



- If weighing is performed in a container put the container on the pan first and then tare it. Then put the declared quantity of pieces on the pan and confirm it when stable (signalled by ):

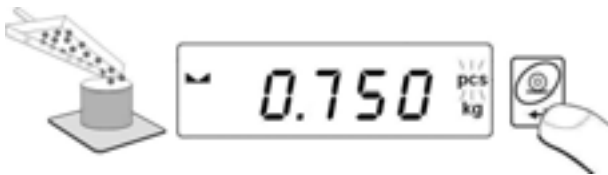

- The program will automatically calculate the mass of a single piece and go on to the **Piece Counting** mode (**pcs**). You will see the following display:



**Notice:**

1. If a user presses the  key when load is not present on the pan, the message **-Lo-** will be indicated for a few seconds and the scale will automatically return to weighing.
2. In order to comply with the rules of appropriate counting pieces put as many pieces as possible during unit mass adjustment. Single piece mass should not be less than 5 divisions.
3. If a single piece mass is lower than a reading interval  $d$  the display will show the **<Err5>** message (see ch. 21. Error messages) and short audible signal will be emitted than the scale returns to weighing.

**Return to weighing:**

- Press the  key twice.

**16.4. +/- control referring to the inscribed standard mass**

**Procedure:**

- Enter to **<HiLo>** function:



- The program enters the window of setting the lower threshold of weighing (**Min**):

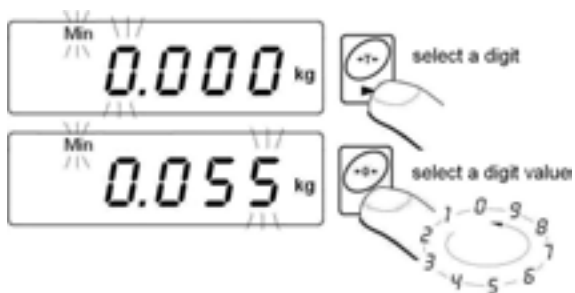

- The inscribed value confirm by pressing , the program will automatically go to the higher threshold of weighing (**Max**):

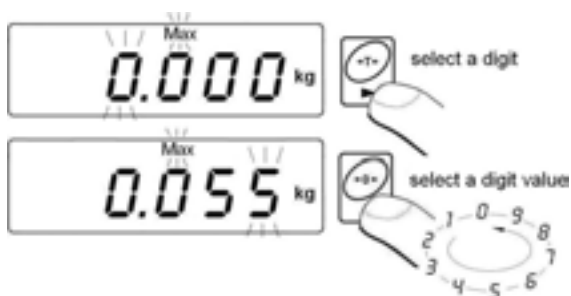

- The inscribed value confirm by pressing , the program will automatically go to the main window.
- During setting threshold values following cases take place:

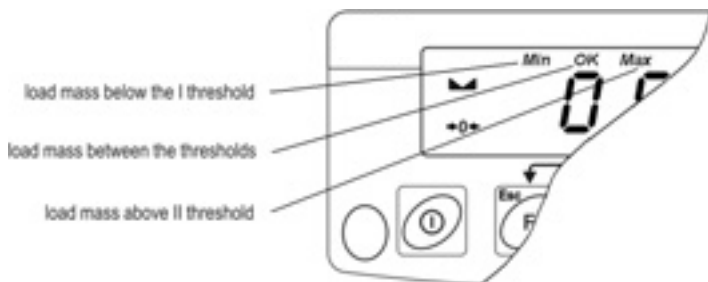

**Notice:**

*If a user erroneously enters a value of the lower threshold higher than the upper one, the scale will indicate an error message and will return to weighing.*

## Return to weighing:

- Press the  key twice.

## 16.5. Control of % deviation referring to the inscribed standard mass

Scale software enables control of deviation (in %) of weighed loads mass referring to the inscribed standard mass. Mass of standard can be determined by its weighing (**PrcA** function) or entered to the scale memory by an user (**PrcB** function).

### 16.5.1. Standard mass determined by its weighing

#### Procedure:

- Enter to **<PrcA>** function:



- You will see **<LoAd>** on the display and then:

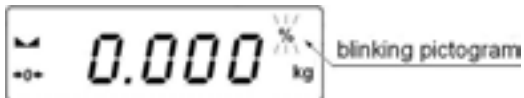

- place an load on the pan which mass will be accepted as standard
- press  to confirm this operating mode
- after few seconds the indication **100,00%** will be displayed
- From this moment display will not indicate mass of weighed load

but deviation of load mass placed on the pan referring to the mass of standard (in %).

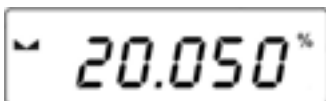

Return to weighing:

- Press the  key twice.

### 16.5.2. Mass of standard inscribed to scale memory





**Procedure:**

- Enter to <PrcB> function:



- The program goes to the weight display window:



- Using  and  set **standard mass**,  
where:  - digit selection,  - digit setting.
- Confirm the entered value by pressing .
- You will see the indication equal to **0,000%**,
- From this moment display will not indicate the mass of weighed load but deviation of the load mass placed on the pan referring mass of standard (in %).

### Return to weighing:

- Press the  key twice.

### 16.6. Automatic tare

This function is useful for fast net mass determination of weighed load in case when tare value of is different for each load. In case when the function is active the cycle of scales operating looks as follows:

- press zeroing key when the pan is empty,
- place the container for pieces,
- when indication is stable **automatic tarring** of the container mass will be performed (**Net** marker will appear in the upper part of the display),
- place a sample into the package,
- display will indicate net mass of sample,
- remove the sample together with the container,
- display will indicate tare mass with minus sign,
- place a container for the next sample. When indication is stable automatic tarring will take place (**Net** marker will appear in the upper part of the display),
- place next sample into the package.

### Procedure:



### Return to weighing:

- Press the  key twice.



## 16.7. Measurement of maximal force on the pan – latch

### Procedure:

- Enter to **<toP>** function:



- Confirmation of choice of **<toP>** function is indication of the **Max** pictogram:



- Apply a force to the weighing pan,
- The display of scale will latch the maximum value of the force,
- Remove loads from the pan,
- Before the next measurement press the  key.

### Return to weighing:

- Press the  key twice.

## 16.8. Totalizing

Scale software is equipped in a totalizing function of single weighings. The totalizing procedure can be documented on the printer connected to the indicator.

### 16.8.1. Enabling the work mode

#### Procedure:



- Enter to **<Add>** function:



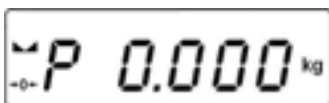

- A letter „P” in the left side of the display is a confirmation that **<Add>** function have been selected:



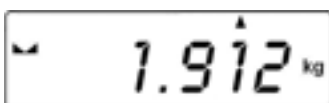

### 16.8.2. Totalizing procedure

- Enter **<Add>** function according to ch. 16.8.1,
- Put the first load on the pan. If the weighing procedure is performed in a container put the container on the pan first and tare it. Then put the first load on the pan and confirm it by pressing  when stable (signalled by ,)
- You will see a sum of weighings on the display, the „▲” pictogram in the upper right corner will be displayed and the weighing result will be printed on the printer connected to the indicator.



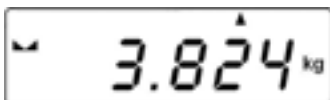

- Take off the load from the pan, indication returns to **ZERO** and the letter „P” in the left part of the display appears,
- Put the next load on the pan,
- After stabilizing press , the sum of first and second weighing will appear on the display, the „▲” pictogram in the upper right corner will be displayed and the second weighing result will be printed on the printer connected to the indicator:



- Press  to complete the procedure (with the loaded or unloaded pan), a sum of all weighings will be printed:

(1) 1.912 kg
(2) 1.912 kg
-----
TOTAL: 3.824 kg





- In case of pressing  one more time with loaded pan, you will see the **<unLoAd>** message. Unload the pan, the scale will return to **ZERO** and the letter „P” in the left part of the display will appear. The scale is ready for the next procedure.

- In case of pressing  one more time with loaded pan, you will see the letter „P” in the left part of the display will appear. The scale is ready for the next procedure.

### 16.8.3. Memory of the last value of sum of weighed goods

After interrupting (e.g. switching off) the totalizing procedure, it is possible to restart the procedure without losing data. In order to do it just enter the totalizing procedure:



- Enter **<Add>** function again according to the ch.16.8.1 of the manual,
- You will see the last memorized sum of weighings on the display

- In order to continue the procedure press , the indication returns to **ZERO** and the letter „P” appears in the left part of the display. The scale is ready for weighing,
- In order to terminate the previous totalizing procedure press  key, , or . You will see the letter „P” in the left part of the display. The scale is ready for weighing.

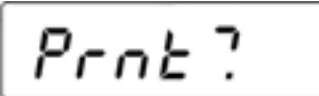

#### 16.8.4. Return to weighing

- Press  key, you will see:

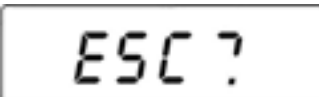

- Before leaving the **<Add>** function it is possible to print out subsequent weighings and the sum of weighings on the connected printer (press  to print, press  to cancel).
- The following message will appear on the display:



- Press  key to return to weighing,
- Press  to return to totalizing.

#### **Notice:**

*In case of overflow of the range of the display in totalizing you will see **<5-FULL>** message in the display. In that case unload the pan and*

*press  to complete the procedure with a printout of sum of all weighings or put a lower mass on the pan which does not cause the overflow error.*

## 16.9. Weighing animals

### Procedure:

- Enter to **<AnLS>** function:



- The **<tinnE>** message appears on the display for **1s**, and then the program goes to the window of setting the duration time (in seconds) of the animal weighing process:

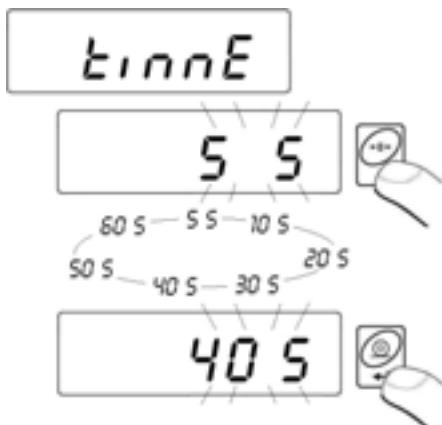

- Confirm the selected value by pressing ,
- You will see the following window:

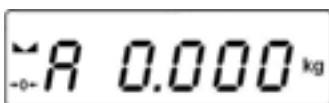

- Load an animal to the platform,
- After exceeding the **-LO-** value (see 14.2), program starts the weighings process. The appearance of subsequent hyphens <-----> showing the progress,
- After completing the process of weighings the result is latched on the display and additionally the **OK** pictogram is shown in the upper part of the display:

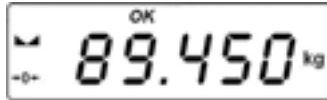

- You can start the procedure of weighing animals again by pressing ,
- After removing the animal from the platform program returns to the window:

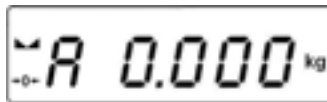

**Return to weighing:**

- Press .

**16.10. Tare memory**

Users are allowed to Enter Up to 9 tare values to the memory.

**16.10.1. Entering the tare value to the scale memory**

**Procedure:**

- Enter to <tArE> function:



- The program goes to displaying the first value from the selection of tare values <tArE 0> (press  to chose different values):



- After selecting the right position press  and you will see an editing field:

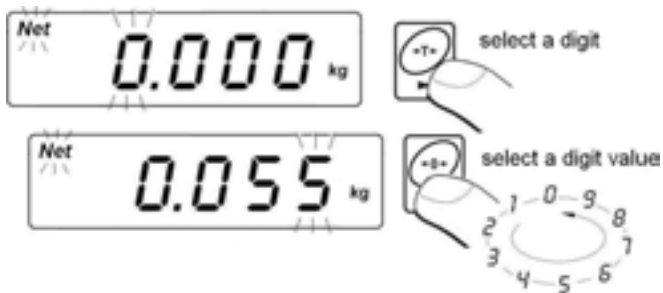

- Enter the selected **tare value** to the scale memory ,

- The program returns to the following window:

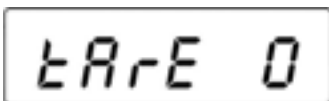

**Return to weighing:**

- Press .

### 16.10.2. Selecting a tare value from the memory

- Enter <tArE> function according to the ch. 16.10.1 of the manual,
- The program goes to displaying the first value from the selection of tare values <tArE 0> (press  to chose different values):



- To use an entered tare value press , you will see the tare value on the display preceded by the „-“ sign and the **Net** pictogram:

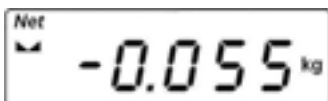

**Caution:**

*A tare value from the memory is not remembered after powering off and on the scale.*



## 17. SCALE CALIBRATION

In precise scales changes of gravitational acceleration have noticeable influence. The gravitational acceleration changes with altitude and latitude. Every scale has to be adjusted to the place of use especially when the place changes. Frequent calibration also prevents weighing process from the influence of humidity and temperature.

For assuring the maximal accuracy of weighing a periodical user calibration is required.

### Calibration should be performed:

- Before weighing process,
- After a long break between series of measurements,
- After the ambient temperature change.

### Conditions of triggering off calibration:

- Automatic internal calibration:
  - Started by adequate temperature change,
  - Started after adjusted time period,
  - Started after powering up the device,
- Manual internal calibration started from the keyboard,
- Calibration with an external weight.

### Caution:

*Internal calibration is accessible only in BWLC...C2 scales of BWLC series. In BWLC...C2 scales calibration with an external weight is not accessible. It should be remembered that the calibration process should be performed with the empty pan! The calibration process can be terminated by pressing **Esc** when necessary.*

### 17.1. Internal calibration

*An option for BWLC...C2 scales of BWLC series only*

The internal calibration process can be initiated manually or automatically. Press **Cal** to initiate it manually. Automatic calibration system performs internal calibration and informs a user on the display about the course of the process.

### 17.1.1. Manual internal calibration

#### Procedure:

- While in weighing mode press ,
- The scale program starts to check stability conditions for the calibration process and displays the following message:

CALIB

- Then the program automatically goes to the internal calibration procedure which is signalled by the following message:

CAL-H

- After completion of the calibration process program returns to the weighing mode,
- Calibration process can be terminated anytime by pressing  which is signalled by the following message on the display:

Abort

#### Notice:

1. It should be remembered that internal calibration should be performed with unloaded pan with keeping possibly constant ambient conditions.
2. If the calibration process lasts longer than 15 seconds scale software will react with <Err8> displayed and a short sound and then the calibration procedure will start again.

### 17.1.2. Automatic internal calibration

The automatic calibration process can be triggered off by 3 different factors:

- **Calibration after powering up**

- After performing the start procedure the scale program starts to check stability conditions for the calibration process and displays the following message:



A rectangular digital display showing the text "CALIB" in a stylized, seven-segment font.

- Then the program automatically goes to the internal calibration procedure which is signalled by the following message:

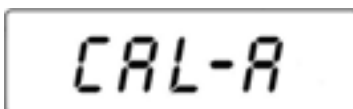

A rectangular digital display showing the text "CAL-R" in a stylized, seven-segment font.

- After completion of the calibration process program returns to weighing mode.

- **Calibration triggered off by temperature changes**

- The scale has been equipped in the temperature monitoring system;
- Temperature triggers off calibration every time when the internal system measures the temperature change greater than 3°C;
- The calibration procedure triggered off by the temperature change starts with checking which is signalled by the following message:



A rectangular digital display showing the text "CALIB" in a stylized, seven-segment font.

- Then the program automatically goes to the internal calibration procedure which is signalled by the following message:

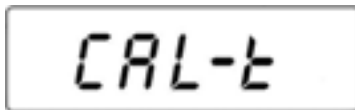

A rectangular digital display showing the text "CAL-t" in a monospaced, pixelated font.

- After completion of the calibration process program returns to the weighing mode.

- **Calibration triggered off by timer**

- The time condition for subsequent automatic calibration is 3 hours. It means that, when no other triggering factor appear, the calibration will appear every 3 hours;
- The calibration procedure triggered off by the time change starts with checking which is signalled by the following message:



A rectangular digital display showing the text "CALib" in a monospaced, pixelated font.

- Then the program automatically goes to the internal calibration procedure which is signalled by the following message:

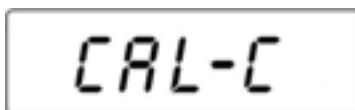

A rectangular digital display showing the text "CAL-C" in a monospaced, pixelated font.

- The program for non-verified scales has a parameter for setting a maximal time interval between subsequent internal calibration.

**Procedure:**

- Enter the submenu **<P6.CAL>** and then:

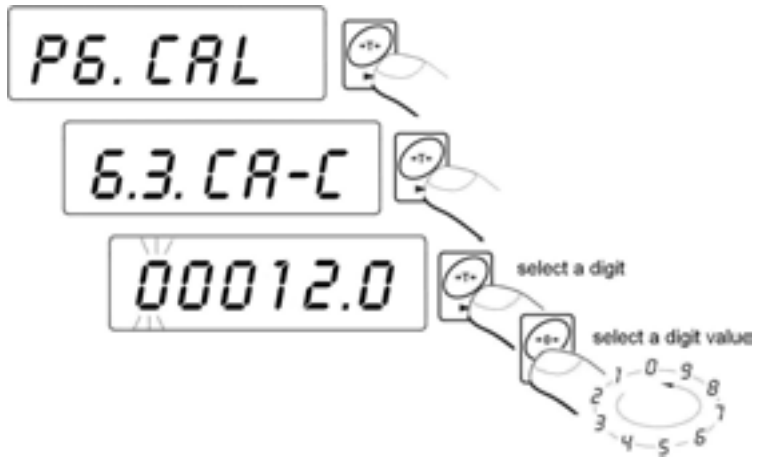

- After completion of the calibration process program returns to weighing mode.

- Calibration process can be terminated anytime by pressing  which is signalled by the following message on the display:

**Abort**

**Notice:**

1. It should be remembered that internal calibration should be performed with unloaded pan with keeping possibly constant ambient conditions.
2. If the calibration process lasts longer than 15 seconds scale software will react with <Err8> displayed and a short sound and then the calibration procedure will start again.

### 17.1.3. A report from calibration

Users, in parameter <P6.4.CA-r>, can enable a function of automatic printout of report form calibration process on a connected printer.

#### Procedure:

- Enter the submenu <P6.CAL> and then:



#### Powrót do ważenia:

*Patrz – punkt 11.2.2. – powrót do ważenia.*

#### The example printout of report from calibration:

```
*****Calibration report*****  
  
Calibration:          internal  
Triggered off by:    init  
Difference:          -00.[5] g  
  
Name: .....
```

## 17.2. External calibration

*Option only for non-verified scales  
Not accessible in BWLC...C2 scales of BWLC series*

### Procedure:

- Enter submenu **<P6.CAL>** and then:



- Following messages will be displayed:



- During this time start mass is adjusted, and after completing the procedure calibration weight mass is displayed (e.g. **3.000kg**),
- Place the required weight on the pan,
- Calibration process starts automatically after placing the adequate weight that is signalled by the following message:



- The completion of the calibration procedure is signalled by the following message:

unLoAd

- Take off the weight from the pan, the message <donE> is displayed for 1s and the program returns to the calibration submenu:

donE

6.2. uCAL

- Calibration process can be terminated anytime by pressing  which is signalled by the following message on the display:

Abort

- Return to weighing with saving changes that have been made.

**Caution:**

*If the calibration process (span adjustment) lasts longer than 15 the <Err8> message will be displayed and short audible signal will be*

*emitted. Press  to perform calibration again with more stable ambient conditions!*

**17.3. Start mass adjustment**

*Option only for non-verified scales  
Not accessible in BWLC...C2 scales of BWLC series*

The scale can require only adjusting new start mass. In this scale adjusting start mass can be excluded from the process of calibration and performed separately.



**Procedure:**

- Enter submenu <P6.CAL> and then:

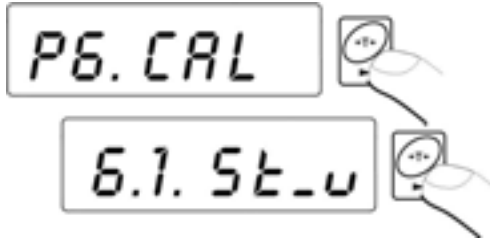

- The following messages are displayed:

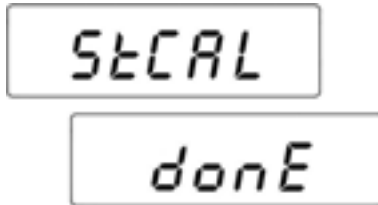

- The new start mass is adjusted and returns to the submenu:

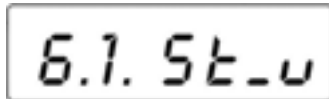

- The process of start mass adjustment can be terminated by pressing , which is signalled on the display:



- Return to weighing with saving changes that have been made.

**Caution:**

*If the start mass adjustment lasts longer than 15 the <Err8> message will be displayed and short audible signal will be emitted. Press  to perform calibration again with more stable ambient conditions!*

## 18. COOPERATION WITH PRINTER



Each time the  key is pressed a current mass value together with mass units is sent to RS 232 interface.

Depending on setting of **STAB** parameter it can be printed out with temporary or stable value. Depending on setting of **REPL** parameter, printout will be automatic or manual.

One of thermal printer in **KAFKA** series can cooperate with each platform scales:

- a) **KAFKA**  
Only result of weighing with mass unit can be printed.
- b) **KAFKA 1/Z**  
This printer is equipped with an internal real time clock. Both date and time can be printed.
- c) **KAFKA SQ S**  
This printer is equipped with an internal real time clock and possibility of running statistics from measurements. Statistic contents: quantity of samples, sum of masses of all samples, average value, standard deviation, variation factor, min value, max value, difference max - min.

### Cable diagrams:

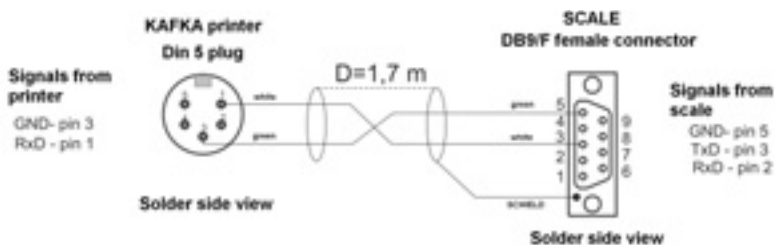

*Scale – Kafka printer cable diagram*

## 19. COOPERATION WITH COMPUTER

Sending weighing results to the computer can be done:

- manually
  - in continuous way
  - automatically
  - on the request from the computer
- after pressing  key,
  - after function activating or sending an appropriate command,
  - After stabilizing the indication
  - After sending a control command

These scales can cooperate with „**EDYTOR WAG**” program. The indicator window comprises the most important information from the scale display. The program allows to configure easily, e.g. design printouts, edit parameters. A precise description is issued in the „Help” file that accompanies the program.

### Cable diagrams:

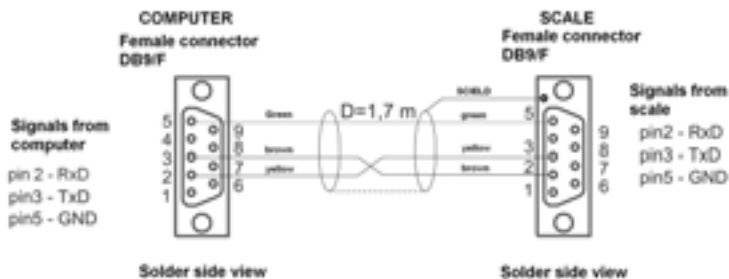

Scale – computer cable diagram

## 20. COMMUNICATION PROTOCOL

### 20.1. General information

- A. A character protocol scale-terminal has been designed for communication between MRC scales and external devices via RS-232 interface.
- B. It consists of commands sent from an external device to the scale and a responses from a scale.
- C. Responses are sent every time after receiving a command (reaction for any command).
- D. Using commands allows users to receive some information about the state of scale and/or influence the operation e.g.:
  - Requesting weighing results,
  - Display control,

### 20.2.A set of commands for RS interfaces

Commands	Description of commands
<b>Z</b>	Zeroing
<b>T</b>	Tarring
<b>TO</b>	Get tare
<b>S</b>	Send the stable result in basic unit
<b>SI</b>	Send the result immediately in basic unit
<b>SU</b>	Send the stable result in current unit
<b>SUI</b>	Send the result immediately in current unit
<b>C1</b>	Switch on continuous transmission in basic unit
<b>C0</b>	Switch off continuous transmission in basic unit
<b>CU1</b>	Switch on continuous transmission in current unit
<b>CU0</b>	Switch off continuous transmission in current unit
<b>PC</b>	Send all implemented commands

#### **Notice:**

1. *Each command have to be terminated in CR LF;*
2. *The best Policy for communication is not sending another command until the former answer has been received.*

### 20.3. Respond message format

After sending a request message you can receive:

<b>XX_A CR LF</b>	command accepted and in progress
<b>XX_D CR LF</b>	command completed (appears only after XX_A)
<b>XX_I CR LF</b>	command comprehended but cannot be executed
<b>XX_^ CR LF</b>	command comprehended but time overflow error appeared
<b>XX_v CR LF</b>	command comprehended but the indication below the
<b>XX_OK CR LF</b>	Command done
<b>ES_CR LF</b>	Command not comprehended
<b>XX_E CR LF</b>	error while executing command – time limit for stable result exceeded (limit time is a descriptive parameter of the scale)

**XX** - command name  
\_ - substitutes spaces

### 20.4. Command's description

#### 20.4.1. Zeroing

Syntax **Z CR LF**

Possible answers:

**Z\_A CR LF** - command accepted and in progress  
**Z\_D CR LF** - command completed  
**Z\_A CR LF** - command accepted and in progress  
**Z\_^ CR LF** - command comprehended but zero range overflow appeared  
**Z\_A CR LF** - command accepted and in progress  
**Z\_E CR LF** - time limit for stable result exceeded  
**Z\_I CR LF** - command comprehended but cannot be executed

#### 20.4.2. Tarring

Syntax: **T CR LF**

Possible answers:

- T\_A CR LF** - command accepted and in progress
- T\_D CR LF** - command completed
  
- T\_A CR LF** - command accepted and in progress
- T\_v CR LF** - command comprehended but tare range overflow appeared
  
- T\_A CR LF** - command accepted and in progress
- T\_E CR LF** - time limit for stable result exceeded
  
- T\_I CR LF** - command comprehended but cannot be executed

### 20.4.3. Get tare value

Syntax: **TO CR LF**

Possible answers:

**TO\_TARA CR LF** - command executed

**Frame format:**

1	2	3	4	5-6	7-15	16	17	18	19	20	21
T	O	space	stability	space	tare	space	unit			CR	LF

- Tare** - 9 characters with decimal point justified to the right
- Unit** - 3 characters justified to the left

### 20.4.4. Send the stable result in basic unit

Syntax: **S CR LF**

Possible answers:

- S\_A CR LF** - command accepted and in progress
- S\_E CR LF** - time limit for stable result exceeded
  
- S\_I CR LF** - command comprehended but cannot be executed
  
- S\_A CR LF** - command accepted and in progress
- MASS FRAME** - mass value in basic unit is returned

**Frame format:**

1	2-3	4	5	6	7-15	16	17	18	19	20	21
S	space	stability	space	sign	mass	space	unit			CR	LF

**Example:**

**S CR LF** – computer command

**S \_ A CR LF** - command accepted and in progress

**S \_ \_ \_ \_ - \_ \_ \_ \_ \_ 8 . 5 \_ g \_ \_ CR LF** – command done, mass value in basic unit is returned.

**20.4.5. Send the result immediately in basic unit**

Syntax: **SI CR LF**

Possible answers:

**SI\_I CR LF** - command comprehended but cannot be executed at the moment

**MASS FRAME** - mass value in basic unit is returned

**Frame format:**

1	2	3	4	5	6	7-15	16	17	18	19	20	21
S	I	space	stability	space	sign	mass	space	unit			CR	LF

**Example:**

**S I CR LF** – computer command

**S I \_ ? \_ \_ \_ \_ \_ 1 8 . 5 \_ k g \_ CR LF** - command done, mass value in basic unit is returned immediately.

**20.4.6. Send the stable result in current unit**

Syntax: **SU CR LF**

Possible answers:

- SU\_A CR LF** - command accepted and in progress
- SU\_E CR LF** - timeout while waiting for stable results
- SU\_I CR LF** - command comprehended but cannot be executed
- SU\_A CR LF** - command accepted and in progress
- MASS FRAME** - mass value in current unit is returned

**Frame format:**

1	2	3	4	5	6	7-15	16	17	18	19	20	21
S	U	space	stability	space	sign	mass	space	unit			CR	LF

**Example:**

- S U CR LF** – computer command
- S U \_ A CR LF** - command accepted and in progress
- S U \_ \_ \_ - \_ \_ 1 7 2 . 1 3 5 \_ N \_ \_ CR LF** - command done, mass value in current unit is returned.

**20.4.7. Send the result immediately in current unit**

Syntax: **SUI CR LF**

Possible answers:

- SUI CR LF** - command comprehended but cannot be executed
- MASS FRAME** - mass value in current unit is returned immediately

**Frame format:**

1	2	3	4	5	6	7-15	16	17	18	19	20	21
S	U	I	stability	space	sign	mass	space	unit			CR	LF

**Example:**

- S U I CR LF** – computer command
- S U I ? \_ - \_ \_ \_ 5 8 . 2 3 7 \_ k g \_ CR LF** - command executed and mass returned



#### 20.4.8. Switch on continuous transmission in basic unit

Syntax: **C1 CR LF**

Possible answers:

**C1\_I CR LF** - command comprehended but cannot be executed

**C1\_A CR LF** - command comprehended and in progress

**MASS FRAME** - mass value in basic unit is returned

**Frame format:**

1	2	3	4	5	6	7-15	16	17	18	19	20	21
S	I	space	stability	space	sign	mass	space	unit			CR	LF

#### 20.4.9. Switch off continuous transmission in basic unit

Syntax: **C0 CR LF**

Possible answers:

**C0\_I CR LF** - command comprehended but cannot be executed

**C0\_A CR LF** - command comprehended and executed

#### 20.4.10. Switch on continuous transmission in current unit

Syntax: **CU1 CR LF**

Possible answers:

**CU1\_I CR LF** - command comprehended but cannot be executed

**CU1\_A CR LF** - command comprehended and in progress

**MASS FRAME** - mass value in current unit is returned

**Frame format:**

1	2	3	4	5	6	7-15	16	17	18	19	20	21
S	U	I	stability	space	sign	mass	space	unit			CR	LF

### 20.4.11. Switch off continuous transmission in current unit

Syntax: **CU0 CR LF**

Possible answers:

**CU0\_I CR LF** - command comprehended but cannot be executed

**CU0\_A CR LF** - command comprehended and executed

### 20.4.12. Send all implemented commands

Syntax: **PC CR LF**

Possible answers:

**PC\_->\_Z,T, TO,S,SI,SU,SUI,C1,C0,CU1,CU0,PC** – command executed, the indicator have sent all the implemented commands.

## 20.5.Manual printouts / automatic printouts

Users can general manual or automatic printouts from the scale.

- Manual printouts can be performed after loading the pan and stabilizing indication by pressing .
- Automatic printouts can be performed only after loading the pan and stabilizing indication.

### **Notice:**

*If a scale is verified printouts of immediate values are blocked.*

### **Format frame:**

1	2	3	4 -12	13	14	15	16	17	18
stability	space	sign	mass	space	unit			CR	LF

**Stability character** [space] if stable  
 [?] if not stable  
 [^] if an indication over the range  
 [v] if fan indication below the range  
**sign** [space] for positive values or  
 [-] for negative values  
**mass** 9 characters justified to the right  
**unit** 3 characters justified to the left  
**command** 3 characters justified to the left

**Example 1:**

\_ \_ \_ \_ \_ 1 8 3 2 . 0 \_ g \_ \_ CR LF – the printout generated from the scale after pressing ENTER/PRINT.

**Example 2:**

? \_ - \_ \_ \_ \_ 2 . 2 3 7 \_ l b \_ CR LF - the printout generated from the scale after pressing ENTER/PRINT.

**Example 3:**

^ \_ \_ \_ \_ \_ 0 . 0 0 0 \_ k g \_ CR LF - the printout generated from the scale after pressing ENTER/PRINT.

**20.6. Continuous transmission**

The indicator can work in a continuous transmission mode. It can be switched on or off in parameters or using RS232 commands.

The frame format sent by the indicator in case of setting <P2.Prt> to **CntA**:

1	2	3	4	5	6	7-15	16	17	18	19	20	21
S	l	space	stability	space	sign	mass	space	Unit			CR	LF

**Stability character** [space] if stable  
 [?] if not stable  
 [^] if an indication over the range  
 [v] if fan indication below the range

**sign** [space] for positive values or  
 [-] for negative values

**mass** 9 characters justified to the right

**unit** 3 characters justified to the left

**command** 3 characters justified to the left

The frame format sent by the indicator in case of setting <P2.Prnt> to Cntb:

1	2	3	4	5	6	7-15	16	17	18	19	20	21
S	U	I	stability	space	sign	mass	space	unit			CR	LF

## 20.7. Configuring printouts

### General information

If some information included are redundant or not sufficient and there is a necessity of changes one can design their own protocol format in **EDYTOR WAG** computer program. This piece of software is accessible in: <http://www.mrclab.com>

## 21. ERROR COMMANDS

- Err2** - Value beyond the zero range
- Err3** - Value beyond the tare range
- Err4** - Calibration mass or start mass beyond the acceptable range ( $\pm 1\%$  for weight,  $\pm 10$  for start mass)
- Err5** - Mass of a single piece lower than the scale division
- Err8** - Exceeded the time for tarring, zeroing, start mass adjustment or span adjustment

- NULL** - Zero value from the AD converter
- FULL2** - Measurement range overflow
- LH** - Start mass error, the mass on the weighing platform is beyond the acceptable range (-5% to +15% of start mass)
- 5-FULL** - Display range overflow in totalizing

**Notice:**

1. Errors: **Err2, Err3, Err4, Err5, Err8, null**, that appear on the display are also signalled by a short beep sound (about 1 sec.);

2. Error **FULL2** that appears on the display is also signalled by a continuous sound until the cause of error disappears.

## 22. TROUBLE SHOOTING

Problem	Cause	Solution
Turning on does not work	Discharged batteries.	Connect to mains or change batteries
	No batteries (not installed or improperly installed)	Check the correctness of installation (polarization)
The scale turns off automatically	„t1” set to „YES” (Power save)	In „othr” submenu change „5.4 t1” to „no”
After turning on „LH” message on the display	Loaded weight pan during powering up	Unload the pan. Then the scale will indicator zero.

## 23. TECHNICAL PARAMETERS

### 23.1. Precisions scales of BWLC series

Scale type:	BWLC 1-A2	BWLC 2-A2	BWLC 6-A2	BWLC 10-A2	BWLC 20-A2
Max capacity	1kg	2kg	6kg	10kg	20kg
Readability	0,01g		0,1g		
Range of tare	-1kg	-2kg	-6kg	-10kg	-20kg
Repeatability	0,03g		0,3g		
Linearity	±0,03g		±0,3g		
Stabilization time	3 sec				
Pan size	195 × 195mm				
Operation temperature	+15°C to +30°C				
Supply	230V AC 50Hz / 11V AC, internal accumulator 6V				
Supplied from batteries	Average operation when supplied from batteries 45h				
Display	LCD (with backlight)				
Net / Gross weight	2,8 / 3,8kg				
Package dimensions	440 x 280 x 190mm				

Scale type:	BWLC 6 C1-R	BWLC 12 C1-R	BWLC 30 C1-R	BWLC 60 C2-R	BWLC 120 C2-R
	BWLC 6 C1-K	BWLC12 C1-K	BWLC 30 C1-K	BWLC60 C2-K	BWLC 120 C2-K
Max capacity	6kg	12kg	30kg	60kg	120kg
Readability	0,1g	0,2g	0,5g	1g	2g
Range of tare	6kg	12kg	30 kg	60 kg	120 kg
Repeatability	0,3g	0,6g	1,5g	3g	6g
Linearity	±0,3g	±0,6g	±1,5g	±3g	±6g
Stabilization time	3 sec				
Pan size	290 × 360mm			400 × 500mm	
Operation temperature	+15°C to +30°C				
Supply	230V AC 50Hz / 11V AC and 6×AA NiMH				
Supplied from batteries	Average operation when supplied from batteries 35h				
Display	LCD (with backlight)				
Net / Gross weight	6,5 / 7,8kg			15,5 / 17,8	
Package dimensions	550 x 420 x 220mm			720 x 580 x 220mm	

## 23.2. Verified precise scales of BWLC series

Scale type:	BWLC 0,6-B1	BWLC 1,2-B1	BWLC 1,2-3-A2	BWLC 3-6-A2	BWLC 6-12-A2
Max capacity	0,6kg	1,2kg	1,2/3kg	3/6kg	6/12kg
Readability	0,01g	0,02g	0,02/0,05g	0,05/0,1g	0,1/0,2g
Range of tare	0,6kg	1,2 kg	3 kg	6 kg	12kg
Repeatability	0,01g	0,02g	0,02/0,05g	0,05/0,1g	0,1/0,2g
Linearity	±0,01g	±0,02g	±0,02/0,05g	±0,05/0,1g	±0,1/0,2g
Stabilization time	3 sec				
Pan size	125 x 145mm		195 x 195mm		
Operation temperature	+15°C to +30°C				
Supply	230V AC 50Hz / 11V AC and 6×AA NiMH		230V AC 50Hz / 11V AC, internal accumulator 6V		
Supplied from batteries	Average operation when supplied from batteries 35h		Average operation when supplied from batteries 45h		
Display	LCD (with backlight)				
Net / Gross weight	1,1 / 2kg		2,8 / 3,8kg		
Package dimensions	320 x 210 x 150mm		440 x 280 x 190mm		

Scale type:	BWLC 6-12 C1-R	BWLC 12-30 C1-R	BWLC 30-60 C2-R	BWLC 60-120 C2-R
	BWLC 6-12 C1-K	BWLC 12-30 C1-K	BWLC 30-60 C2-K	BWLC 60-120 C2-K
Max capacity	6/12kg	12/30kg	30/60kg	60/120 kg
Readability	0,1/0,2g	0,2/0,5g	0,5/1g	1/2 g
Range of tare	-12kg	-30kg	-60kg	-120 kg
Repeatability	0,1/0,2g	0,2/0,5g	0,5/1g	1/2 g
Linearity	±0,1/0,2g	±0,2/0,5g	±0,5/1g	±1/2 g
Stabilization time	3 sec			
Pan size	290 × 360mm		400 × 500mm	
Operation temperature	+15°C to +30°C			
Supply	230V AC 50Hz / 11V AC and 6×AA NiMH			
Supplied from batteries	Average operation when supplied from batteries 35h			
Display	LCD (with backlight)			
Net / Gross weight	6,5 / 7,8kg		15,5 / 17,8kg	
Package dimensions	550 x 420 x 220mm		720 x 580 x 220mm	

### 23.3. Precise scales of BWLC...C2 series

<b>Scale type:</b>	<b>BWLC 1-A2-C2</b>
Max capacity	1kg
Readability	0,01g
Range of tare	-1kg
Repeatability	0,03g
Linearity	±0,03g
Stabilization time	3 sec
Pan size	195 × 195mm
Operation temperature	+15°C to +30°C
Supply	230V AC 50Hz / 11V AC, internal accumulator 6V
Supplied from batteries	Average operation when supplied from batteries 45h
Display	LCD (with backlight)
Net / Gross weight	3,6 / 4,6kg
Package dimensions	560 x 330 x 230mm

### 23.4. Verified precise scales of BWLC...C2 series

<b>Scale type:</b>	<b>BWLC 0,6-A1-C2</b>	<b>BWLC 1,2-A2-C2</b>	<b>BWLC 3-A2-C2</b>	<b>BWLC 6-A2-C2</b>
Max capacity	0,6kg	1,2kg	3kg	6kg
Min capacity	0,5g	1g	2,5g	5g
Readability	0,01g	0,02g	0,05g	0,1g
Repeatability	0,01g	0,02g	0,05g	0,1g
Linearity	±0,01g	±0,02g	±0,05g	±0,1g
Range of tare	-0,6kg	-1,2kg	-3kg	-6kg
Stabilization time	3 sec			
Pan size	128 x 128mm	195 × 195mm		
Operation temperature	+15°C to +30°C			
Supply	230V AC 50Hz / 11V AC, internal accumulator 6V			
Supplied from batteries	Average operation when supplied from batteries 45h			
Display	LCD (with backlight)			
Net / Gross weight	3,6 / 4,6kg			
Package dimensions	560 x 330 x 230mm			



## 24. ADDITIONAL EQUIPMENT

### Accessories:

- KAFKA printer cable - **P0136**,
- Computer cable - **P0108**,
- EPSON printer cable - **P0151**,
- Power cord for car lighter 12V DC - **K0047**,
- Thermal printer - **KAFKA**,
- Dot matrix printer - **EPSON**,
- Additional display in plastic casing for BWLC-A and BWLC-C scales - **WD- 4/1** (accessible with balance as complete set only),
- Current loop in plastic casing - **AP2-1**,
- RS232 / RS485 converter for PUE C/31 – **KR-01**,
- RS232 / Ethernet converter for PUE C/31 - **KR-04**,
- Stainless steel vibration damping table- **SAL/N**,
- Milded steel vibration damping table- **SAL/M**,
- A case for save carring/transporting a scale of BWLC-A series – **W1**,
- A case for save carring/transporting a scale of BWLC-C1-K series – **W2**,
- A frame for weighings loads under a scale of BWLC-A2, BWLC-A2-C2 series,
- Mass standards with accessories.

### Computer programs:

- "EDYTOR WAG" computer program,
- "RAD-KEY" computer program,
- "PW-WIN" computer program.